

AirWave[®] 1

OPERATING INSTRUCTIONS



Contents

Contents	0
Safety guidelines	1
Air cushion types – Type 7 filler	2
Air cushion types – Type 8 wrapper	3
Machine overview	4
Technical data	4
Recommended settings	5
All other settings for Floeter air cushion chains and mats can be found here :	5
Accessories and spare parts	6
Operating instructions	7
Control panel settings	9
Preset and lock function	10
Change the knife	11
Change the Transport belts	14
Change the Counter pressure block	17
Film guide pins	19
Error codes	19
Options and expandability	20
Maintenance & Cleaning	22
Warranty	23
Declaration of Conformity	23
Notes	24
Support and Service	25

Safety guidelines

Please read the safety guidelines and operating instruction closely before using the machine.



- Turn off the machine and disconnect power before opening the machine or performing any repair or maintenance work on the machine.
- Switch off the machine if it will not be used for an extended period of time.
- Do not insert any objects into the machine when it is connected to power.
- To prevent the risk of electric shock, ensure that the machine does not come into contact with liquids.



- Do not operate the machine without the covers for the machine components.
- Keep hair and loose clothing away from the film feed mechanism.
- Place the machine only on surfaces that are adequately large, stable, flat, and horizontal.

This machine is designed for safe operation in compliance with the use, instructions, and guidelines specified in these operating instruction.

All persons who use this machine must be familiar with the content of these operating instructions and must carefully follow the safety guidelines.

FLOETER shall not be responsible for damage resulting from improper use of the machine or non-observance of the safety guidelines.

Air cushion types – Type 7 filler

Our standard version – Polyethylene 20 µm



Type 7.1 AirWave air cushion filler 100 x 210 mm; 20 µm; 700 m
Ideal for filling small voids and for use as an intermediate layer



Type 7.2 AirWave air cushion filler 150 x 210 mm 20 µm; 700 m
Ideal for filling medium-sized voids and for use as an air cushion ring



Type 7.3 AirWave air cushion filler 200 x 210 mm; 20 µm; 700 m
Ideal for filling large voids



Type 7.4S AirWave air cushion filler 130 x 280 mm; 20 µm; 600 m
Ideal for filling large voids



Type 7.5S AirWave air cushion filler 240 x 280 mm; 20 µm; 600 m
Ideal for filling large voids

*All type 7.x are also available as Jumbo rolls with more running meters per roll, and also in 15µm or 12µm, in pink antistatic version, in our „Heavy Duty“ Version made of compounding material, or as 100% biodegradable and paper material.
Get in touch with us.*

Air cushion types – Type 8 wrapper

Our standard version – Polyethylene 20µm

8.1-8.6 with 450 m; 8.3XL/8.4XL (600mm) with 300 m



Type 8.0 AirWave wrapper 420mm 1 large chamber; 20µm; 450 m
1 large chambers for large volumes and for use as a top layer



Type 8.1 AirWave wrapper 420mm 2 large chambers; 20µm; 450 m
2 large chambers for large volumes and for use as a top layer



Type 8.2 AirWave wrapper 420mm 2 small chambers; 20µm; 450 m
2 chambers for moulded components, edge protection, and wrapping



Type 8.3 AirWave wrapper 420mm 4 chambers; 20µm; 450 m
4 chambers for use as an intermediate layer, wrapping, and envelope



Type 8.4 AirWave wrapper 420mm 8 chambers; 20µm; 450 m
8 chambers for use as an envelope and intermediate layer



Type 8.5 AirWave wrapper 420mm 7 wavy chambers; 20µm; 450 m
7 chambers for use as an envelope and intermediate layer



Type 8.6 AirWave wrapper 420mm cloud type chambers 20µm 450lfm
4 chambers for use as an envelope and intermediate layer

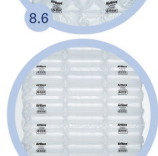

Type 8.9-600 AirWave wrapper 600mm 3 chambers; 20µm;450lfm
3 chambers for use as an envelope and intermediate layer

All type 8.x are also available as Jumbo rolls with more running meters per roll, and also in 15 µm or 12 µm, in pink antistatic version, in our „Heavy Duty“ Version made of compounding material, or as 100% biodegradable or paper material. Get in touch with us.

Machine overview

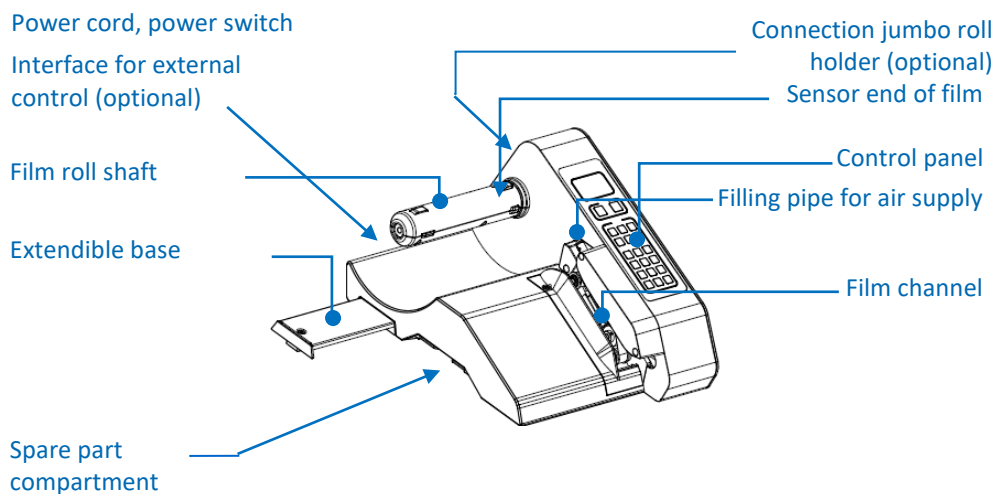

Technical data

Power supply:	230 V; 50 Hz / 120 V; 60 Hz
Power consumption:	115 W (20 W Stand-By)
Production speed:	8-10 m / min
Weight:	5,6 kg
Colour:	Standard: anthracite / blue (individual on request)
AirWave1 dimensions (LxWxH):	413 x 316 x 232 mm (extendible base 150mm)
Bluetooth interface:	optional

Recommended settings

Cushion Type	Recommended Temperature [°C]	Recommended Air Volume [%]
PE (20µm) / ClimaFilm (20µm):		
7.1	170-180	26-30
8.3	170-180	65-70

All other settings for Floeter air cushion chains and mats can be found [here](#):

SETTINGS



AirWave1

Accessories and spare parts



Hex key (4 pcs)



Teflon belt (1 pcs)



Knife (1 pcs)



Power cord (1 pcs)



Fuse (1 pcs)



Film guide pins (2 pcs)

Operating instructions

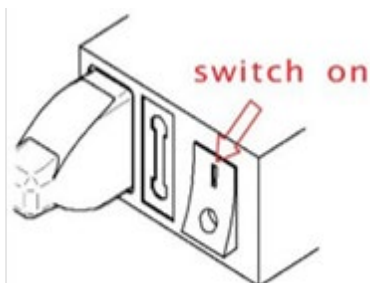

Connect power to the machine and switch on the machine.

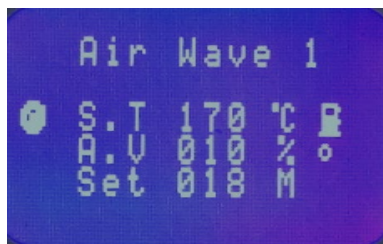

The start screen will appear automatically after approximately 5 seconds on the control panel.

Insert film roll

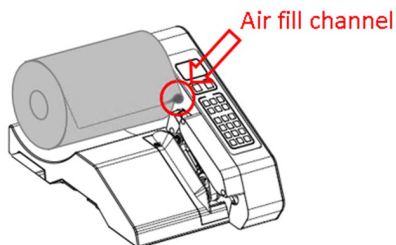

Load the roll of film on to the film roll shaft. Please note the side of air fill channel of the film. The channel must be on the side closest to the machine.

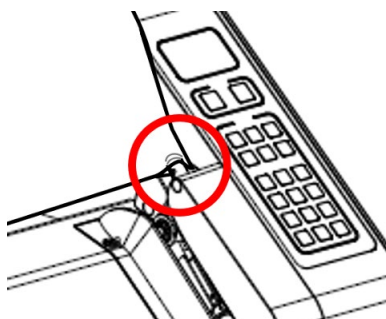

Guide the air fill channel of the film onto the air nozzle. Slide the film on the air nozzle a few more cm forward in direction of sealing unit. That will simplify the next step.

OPERATING INSTRUCTIONS

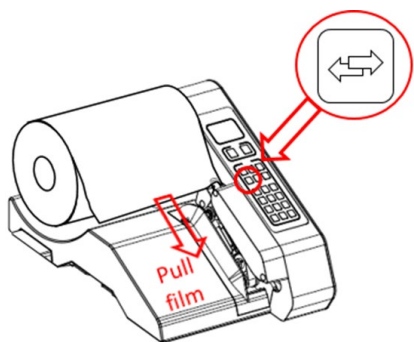

Pull the film above the air nozzle and through the film channel. Press the "IN/OUT button" and pull the film all the way through.



The corner of the film can be cut at an angle to make it easier to fit the film over the air nozzle.

Control panel settings



Use the control panel to set the sealing temperature, film length, and air volume. Once a roll of film is loaded and all settings are correct, press "Start" to start the production of air cushions.

Setting the sealing temperature **S.T 170 °C**

The preset sealing temperature is 170°C.

To change the sealing temperature, press "SET" and enter the required temperature. Press „ENTER“ to continue and „ESC“ to end adjustment function. The machine will start heating-up or cooling down to required temperature. During this process the display will show the flashing symbol .

The progress bar display the current status of sealing temperature like a thermometer.

Once the machine reaches the set temperature, the symbol flashing  will change to durable and filled .

Please have a little patience. The production can start only when set temperature is reached. If the „START“ button has been pressed during heating or cooling process, the machine would be in waiting mode and would start production independent when target temperature has been reached.

Setting the film length **Set 000 M**

The length of the air cushion strand you want to produce can be preset in meters, as needed. This value is set to 0 by default, which tells the machine to produce air cushions continuously. Press three times "SET" and enter the requested length. Press „ENTER“ to continue and „ESC“ to end the adjustment function. Press "START" to start the production. The machine will stop automatically once the preset air cushion strand length has been reached.

Please note: the machine will save the set length until you delete or change the length.

Setting the air volume **A.U 020 %**

Set the air volume you want by pressing the buttons "+" and "-" next to the display. The air volume can be set between 0 - 100 %. Use the recommended air volume for the respective film types.

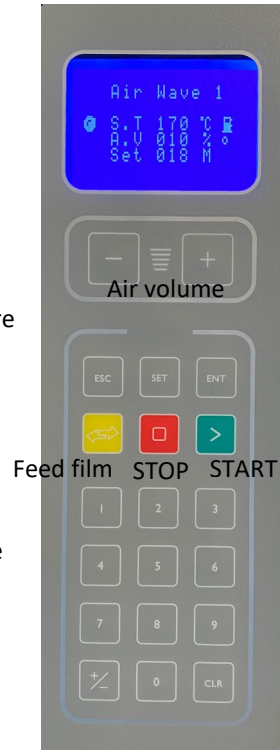

Preset and lock function

Four presets with temperature, air volume and blowing time are possible for a quick selection. Programming the presetting can be done at programming level.

To **program or change a preset** press 2-3 sec."0" and enter "4-5-6". Press "SET" to get to the requested value. Adjust setting and press "ENT" to continue and get to the next setting. Press "ESC" to get back to foreman / control level.



Factory-adjusted: M1 for type 7.1 PE-Film 20µm; M2 for type 8.3 PE-Film 20µm

For **quick selection** you have to be at foreman / control level. Press long time the number of requested program position and settings will be set. 1, 2, 3 or 4.



Control panel can be locked, to prevent setting changes by unauthorized person.

Please ask your foreman for the code to lock or unlock the control panel.

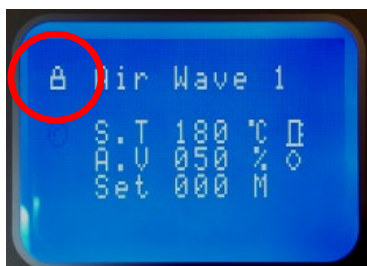

Change the knife

You can easily change the knife for AirWave1 yourself.

Step 1: Switch off the machine and disconnect power



Always switch off the machine before opening it.



Disconnect power to the machine by removing the power cord completely from the machine.
Allow the machine to cool down!



You must follow this step. It is for your safety.

Step 2: Remove the cover



Undo screws and remove the upper cover.

OPERATING INSTRUCTIONS

Step 3: Remove the knife

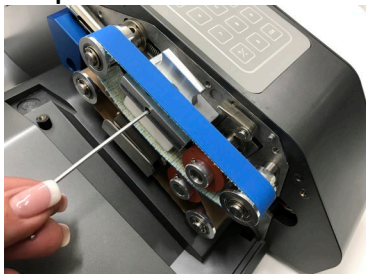

Undo the locating screw with the provided hex key.



Remove the blade bracket.

Caution!! Even used blades are extremely sharp!

Step 4: Change blade



Undo the little screw which fixes the blade with the provided hex key.

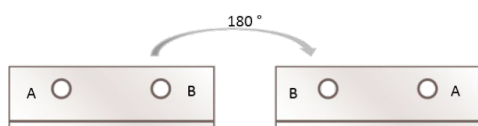

Turn around the blade one time 180° or apply a new one if both sides were already used.



Fix the blade with the corresponding screw.

OPERATING INSTRUCTIONS

Step 5: Insert the knife

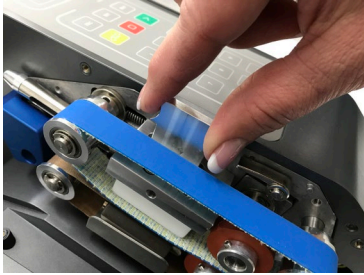

Insert the knife into the slot at the machine

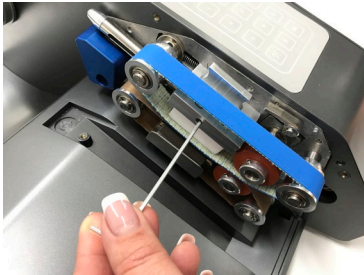

and fix it with the screw.



Remount the upper cover and fix it with the screws with provided hex key.

Change the Transport belts

You can easily change the Teflon belts for AirWave1 yourself.

Step 1: Switch off and disconnect power



Switch off the machine and disconnect power
Always switch off the machine before opening it. **Disconnect power** to the machine by removing the power cord completely from the machine.



Allow the machine to cool down!

Step 2: Remove the covers



Undo screws and remove the upper cover first and after that the lower cover.

Step 3: Loosen transport rolls

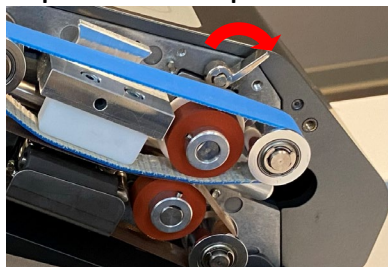

Turn the tension lever to move the transport rolls apart.

OPERATING INSTRUCTIONS

Step 4: Release transport / Teflon belt

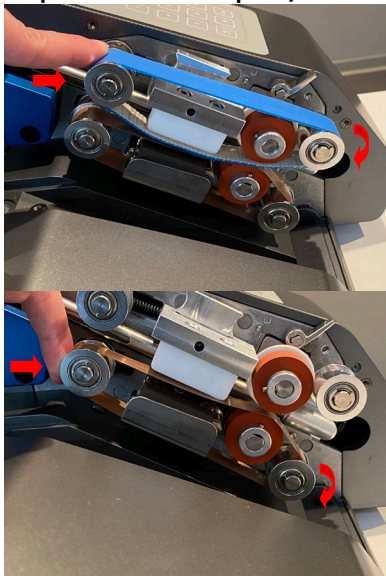

Same steps for transport as for Teflon belt:

Push the upper hinder guiding roll toward the one in the front against the spring, and release the tension for the transport belt. Remove the slackened transport belt

Step 5: Insert new transport / Teflon belt

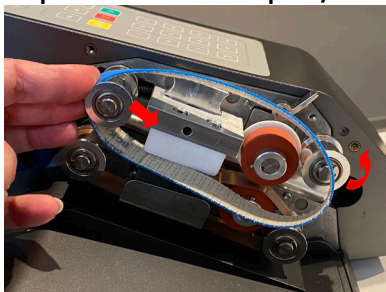

Same steps for transport as for Teflon belt:

Place the new belt over the hinder transport roll, push the roll toward the roll in the front place the belt over the front roll and loosen the pressure.



Gently turn the rollers to check whether the belt is situated correctly between the seal pads. The belt should be able to move free.

OPERATING INSTRUCTIONS

Step 6: Tension the belts, close the machine.

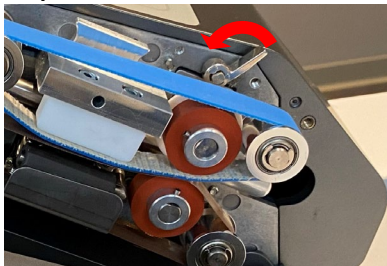

Turn the tension lever back to the left to press the transport rolls against each other.



Fit the covers of the Teflon belts and screw it with the prepared hex key. Lower cover first and then the upper one.



Now you can reconnect the power cord and switch on the machine.

Change the Counter pressure block

The counter pressure block of AirWave1 can easily be changed by yourself.

Step 1: Switch off and disconnect power



Switch off the machine and disconnect power

Always switch off the machine before opening it. **Disconnect power** to the machine by removing the power cord completely from the machine.



Allow the machine to cool down!

Step 2: Remove the covers



Undo screws and remove the upper cover first and after that the lower cover.

Step 3: Loosen transport rolls



Turn the tension lever to move the transport rolls apart. And remove transport belts as per description.

Step 4: Change Teflon block

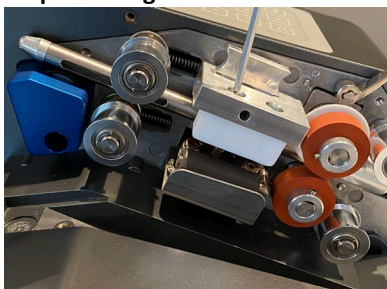

Unscrew counter pressure block and remove.

OPERATING INSTRUCTIONS



Replace counter pressure block with a new and fasten the screws.

Step 5: Tension the belts, close the machine.



Turn the tension lever back to the left to press the transport rolls against each other.



Fit the covers of the Teflon belts and screw it with the prepared hex key.
Lower cover first and then the upper one.



Now you can reconnect the power cord and switch on the machine.

Film guide pins

For a more effective air volume or better film guide for the film Types 8.3 - 8.5 use the two guiding pins.



Screw the pins at the machine casing



Thread the film trough the pins and over the airpipe.
Start production.

Error codes

The AirWave1 has an integrated diagnostic program. In the event of an error, an “E” code will appear on the display. This code will help you correct the error:

- „Foil Empty“: film roll empty.
- „Check Foil“: refeed film on to the airpipe
- „Heat Error“: please contact our Floeter Service if this Error will occurs repeatedly or if it would not be possible to quit.

Options and expandability

Please contact your sales advisor for further information.



Distance controlled production by Bluetooth connection.
With tablet or smartphone

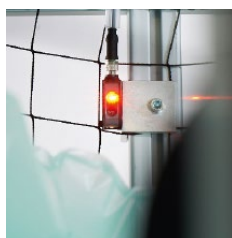

Fully automated control by the installation of a filling level sensor.

Optimal for overhead compartment or mobile air cushion storage.



Start-/Stop function with foot pedal.

For a production on demand. Even if you have no free hand or if machine is inaccessible.



AirWave 1/2 Jumbo roll holder
for bigger rolls



AirWave 1/2 Overhead Solution
For an automated air cushion stockage in ideal working height

OPERATING INSTRUCTIONS



AirWave1/2 Rolling basket

always brings your air cushions to the ergonomically correct working height. Locally flexible.



AirWave 1/2 Mobile table solution

Bring your machine to the ideal working height.
(compatible with Docking station)



AirWave 1/2 Docking station

For an decentralized consumption with mobile rolling container completely independent of machine position.



AirWave1/2 Coiler Unit

For the production of endless rolled sheets of the cushion mats

Maintenance & Cleaning

The AirWave1 is a low maintenance machine.
Mechanically claimed parts can show traces of abrasion after certain operating time.
Furthermore there can occur contamination or residue of at the AirWave1.

Our recommendation:

All 30 roll changes and on demand:

- 1) Check Teflon belts and replace as the circumstances require
- 2) Check red transport rolls regarding contamination and grip clean or replace if necessary
- 3) The gear wheels always need to be sufficiently greased

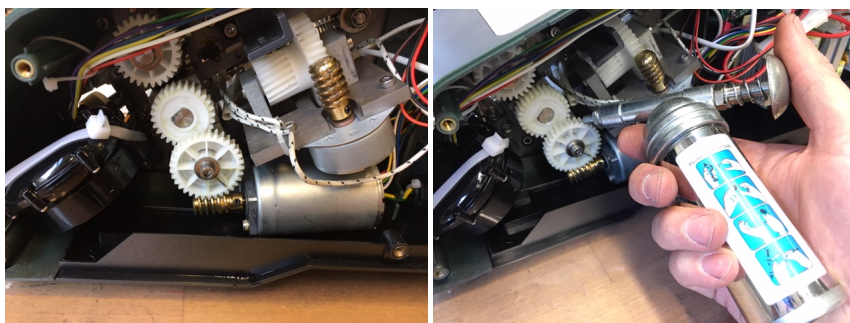

- 4) Check knife, see the cutting of the film, if necessary turn 180° or replace
- 5) If necessary clear the machine of contamination and residue of film. Consider also knife slot at air pipe, sealing block and other areas of the machine.

All 100 roll changes

- 6) Check transport belt and counter pressure block and replace as the circumstances require

Warranty

AirWave1 has a 12-month manufacturer's warranty that covers all electronic and mechanical components. The warranty period starts automatically when you purchase the machine.

In the event of damage, please contact our back office (please see contact below).

If the machine needs to be send back to us, please follow the steps discussed with our service team.

Your machine will be returned to you immediately once the repair is finished.

If you need a replacement machine, the warranty period will continue from the receipt date of the first machine. The warranty will not be extended.

The scope of the warranty does not include the following:

- Damage resulting from improper use of AirWave1:
- This includes, in particular, damage caused by using unsuitable films or inserting foreign objects into the machine's transport belts.
- Wear and tear caused by regular use
- Wearing parts, in particular, Teflon transport belts, knives, and transport rollers
- Damage caused by machine downtimes

Contact:

FLOETER Verpackungs-Service GmbH
Robert-Bosch-Str. 17
71701 Schwieberdingen
Germany

tel: 0800 FLOETER (free within Germany)

e-mail: info@floeter.com

tel: +49 (0) 71 50 / 9 23 96-0

www.floeter.com

Declaration of Conformity

The machine AirWave1 and it's equipment is compliant with the relevant harmonized standards listed according to the European EMC Directive, 2014/30/EU and LVD Directive 2014/35/EU. The compliance was verified by an independent specialized certifying company.

Technical records available on request.

Notes

Notes

Support and Service

If you need support, advice or do you have any questions?

We are here for you: www.floeter.com/en/support/

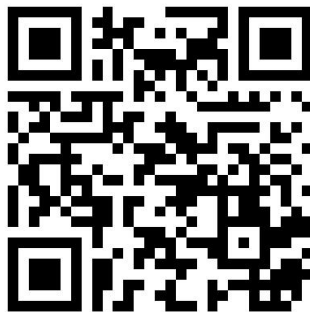

FLOETER Verpackungs-Service GmbH
Robert-Bosch-Straße 17
71701 Schwieberdingen
Germany

tel.: +49 (0) 7150 / 92396 - 0
Info@floeter.com

www.floeter.com